

Full Length Research Paper

The maize seed system in Ethiopia: challenges and opportunities in drought prone areas

Dawit Alemu^{1*}, Wilfred Mwangi², Mandefro Nigussie¹ and David J. Spielman³

¹Ethiopian Institute of Agricultural Research (EIAR), Melkassa Research Center, P. O. Box 436, Nazareth, Ethiopia.

²International Maize and Wheat Improvement Center (CIMMYT), P.O. Box 1041 Village Market-00621, Nairobi, Kenya.

³International Food Policy Research Institute, IFPRI Addis Ababa, P. O. Box 5689, Addis Ababa, Ethiopia.

Accepted 14 March, 2020

This study examines how the performance of the maize seed system in Ethiopia affects small-scale farmers' access to and use of improved maize varieties. Particular emphasis is given to the drought-prone agro-ecologies of the Rift Valley region and the specific maize varieties developed for and disseminated in this area. Data for this study were gathered in 2005 from focus group discussions with maize farmers across three districts in the Rift Valley; household surveys of a random sample of 60 maize farmers; key informant interviews with public and private sector stakeholders in the maize seed market; and government and industry secondary sources. Findings show that despite extensive varietal development by the public research system, dissemination of improved varieties to farmers remains limited. This may be partially due to the continued dominance of public sector organizations in the multiplication and supply of seed to farmers, and to the relatively low level of private sector participation. The result is a seed market characterized by limited competition, insufficient supply of seed relative to demand, limited choice in the few varieties that are available, and excessively high costs of maize seed production. Without significant structural and organizational change to the maize seed system, these market and institutional failures will continue to hamper smallholder access to improved varieties developed for drought-prone regions such as the Rift Valley.

Key words: Maize, seed systems, drought-prone agro-ecologies, Ethiopia.

INTRODUCTION

Discussions of agriculture and rural development in Ethiopia inevitably lead to the subject of seed. Through a combination of modern science and modest changes in farmer cultivation practices, improved seed can yield remarkable abundance for small-scale farmers in Ethiopia. This abundance can contribute to greater production and productivity in the agricultural sector while also addressing the country's food security and poverty reduction challenges (Dawit and Spielman, 2006; Dawit et al., 2004; Deressa et al., 2001).

Maize and improved maize varieties are particularly important in this context. Maize is currently grown across 13 agro-ecological zones which together cover about 90 percent of the country. Moreover, it is an increasingly popular crop in Ethiopia: The area covered by improved

maize varieties grew from five percent of total area under maize cultivation in 1997 to 20 percent in 2006 (Byerlee et al., 2007; CSA 2006, 2004, 2001).

Maize cultivation is also a largely smallholder phenomenon in Ethiopia. The small-scale farmers that comprise some 80 percent of Ethiopia's population are both the primary producers and consumers of maize in Ethiopia.

In support of the growing popularity of maize, an extensive maize seed industry has emerged in Ethiopia over the last several decades. Seed industry players include public sector research organizations and extension services; market actors such as private breeders, seed companies, stockists, and trade associations; civil society actors such as non-governmental, farmer and community-based organizations; and farmers themselves (Dawit and Spielman, 2006; Mywish et al., 1999).

The recent introduction of several new maize varieties in Ethiopia illustrates the potential importance of this seed industry and the contribution of improved maize varieties to Ethiopia's agricultural sector. Several drought tolerant

*Corresponding author. Email: dawit96@yahoo.com.

Tel: +251 221 112186. Fax: +251 221 114623.

and nitrogen-use efficient maize varieties—namely, Melkassa II, III, IV and V—were developed in the 1990s under the first phase of the African Maize Stress (AMS) project, a joint undertaking of the International Maize and Wheat Improvement Center (CIMMYT) and national agricultural research institutes across Eastern and Southern Africa (Banziger and Diallo, 2001; Banziger and Diallo, 2002; Worku et al., 2002; Diallo et al., 2002; Muasya and Diallo, 2002; and Siambi et al., 2002).

These varieties were specifically adapted to the semi-arid agro-ecologies of Ethiopia's Rift Valley, an area comprising the central part of the country and characterized by lowland to intermediate agro-ecologies with access to relatively greater irrigation than other parts of the country. Their potentially significant impact on yields and output has been demonstrated through extensive field trials. For instance, field demonstration of Melkassa II variety in 2006/07 production season showed 22.7% average yield advantage as compared to the local varieties in the rift valley area (Bedru, 2007)

Yet while these varieties are currently being promoted through demonstration trials with smallholders throughout the Rift Valley area, widespread adoption has been tempered by difficulties in delivering improved seed to smallholders. Despite an active agricultural extension system, a sizeable state-owned seed enterprise, and the recent liberalization of seed market regulations, the availability and adoption of improved seed in the Rift Valley area remains low (Muhammad et al., 2003).

The purpose of this study is to examine the performance of the maize seed system in Ethiopia—from research to certification to production to distribution—and understand its effects on smallholder access to, and use of, improved maize varieties. The paper begins with a review of the study methodology in Section 2, followed by an assessment of maize seed system structures and actors in Section 3. Following a review of performance figures for maize seed production in Section 4, the paper then provides an estimation of improved maize seed adoption among smallholders in Section 5. The paper concludes in Section 6 with recommendations designed to promote structural and organizational change in the maize seed system, address the inherent market and institutional failures, and potentially increase smallholder access to improved maize varieties in the Rift Valley area.

METHODOLOGY

The primary data for this study were collected in 2005 from farmers in Ethiopia's Rift Valley area, and were supplemented with secondary data from government and industry sources. The data and data sources are described in detail here, followed by a discussion of the analytical model used to interpret the data.

The first set of data was collected from maize farmers in the study area using rapid rural appraisal techniques highlighted by focus group discussions. Pre-prepared checklists of questions were used to query farmers on their maize production levels, cultivation practices, varietal adoption decisions, seed supply issues, and

other relevant topics. A second, more specific data set was compiled from household surveys of a sample of 60 randomly-selected farmers from six *kebeles* (peasant associations) in three *woredas* (districts) (namely Arsi Negele, Dugda Bora, and Bosset *woredas*) in the study area. The survey was based on a standard questionnaire on varietal adoption decisions. A third set of data and information were collected from different public agencies and private companies directly and indirectly involved in the seed industry, and are in reference to 2005/06 maize production season. These data are discussed in detail in the sections that follow.

The analysis of Ethiopia's maize seed industry is driven by methods developed for other country and regional analyses of the topic. For example, Tripp (2001) and Tripp and Rohrbach (2001) provide the tools needed to identify and understand the importance of information asymmetries in seed markets between buyers and sellers, arguing that reliable information transmission systems—certification systems, labeling regulations, and consumer protection laws—are necessary methods of overcoming such asymmetries. Tripp and Louwaars (1997) provide insights needed to analyze the liberalization of seed industries in developing countries, suggesting that while the privatization of state-owned seed monopolies, reduction of barriers to market entry, and relaxation of germplasm and seed import restrictions have been pursued in many countries quite successfully, deregulation—the reduction in the rules and procedures designed to regulate the production and distribution of seed—runs the risk of exacerbating existing information asymmetries. Morris et al., (1998a), Tripp and Rohrbach (2001), and Bett et al. (2003) provide further insights into the analysis of private investment in seed multiplication, marketing, and distribution in developing countries (see also Gerpacio (2003), Tripp and Pal (2001), and Morris et al., (1998b), among others).

The analysis of farmer adoption decisions in Ethiopia is based broadly on models developed to estimate the spillover effects of learning externalities among farmers first introduced by Besley and Case (1994) and Foster and Rosenzweig (1995). These studies illustrate how different types of learning play a role in the agricultural transformation process, and describe the importance of distinguishing between the effects of learning by doing (a function of one's own innovative capabilities) and learning from others (a function of one's social networks) with respect to the adoption of improved varieties. Their findings suggest that while imperfect knowledge about improved variety management is a barrier to adoption, the barrier is decreasing with a farmers' experience with the variety *and* with his or her neighbors' experience.

Importantly, these studies have motivated the emergence of a rich literature on high-yielding varietal adoption in India during the Green Revolution of the late 1960s and early 1970s. Bardhan and Udry (1999) extend the model to examine wider development implications of social learning. By linking technological innovation to investment in human capital, they demonstrate that in the presence of imperfect labor markets, the absence of technological innovation and underinvestment in human capital are mutually reinforcing. Munshi (2004) adds further nuance to the social learning model by demonstrating how information flows relating to a new technology are weaker in heterogeneous populations. Bandiera and Rasul (2006) add yet another twist by modeling social learning as a non-linear process and testing it with a study of sunflower adoption in northern Mozambique.

Ethiopia's maize seed system: structures and actors

We examine here the structure of the maize seed industry in Ethiopia, with specific emphasis placed on the roles played by each in the areas of research, breeding, and biodiversity conservation; seed industry regulation and management; and player production, marketing, and distribution (Figure 1).

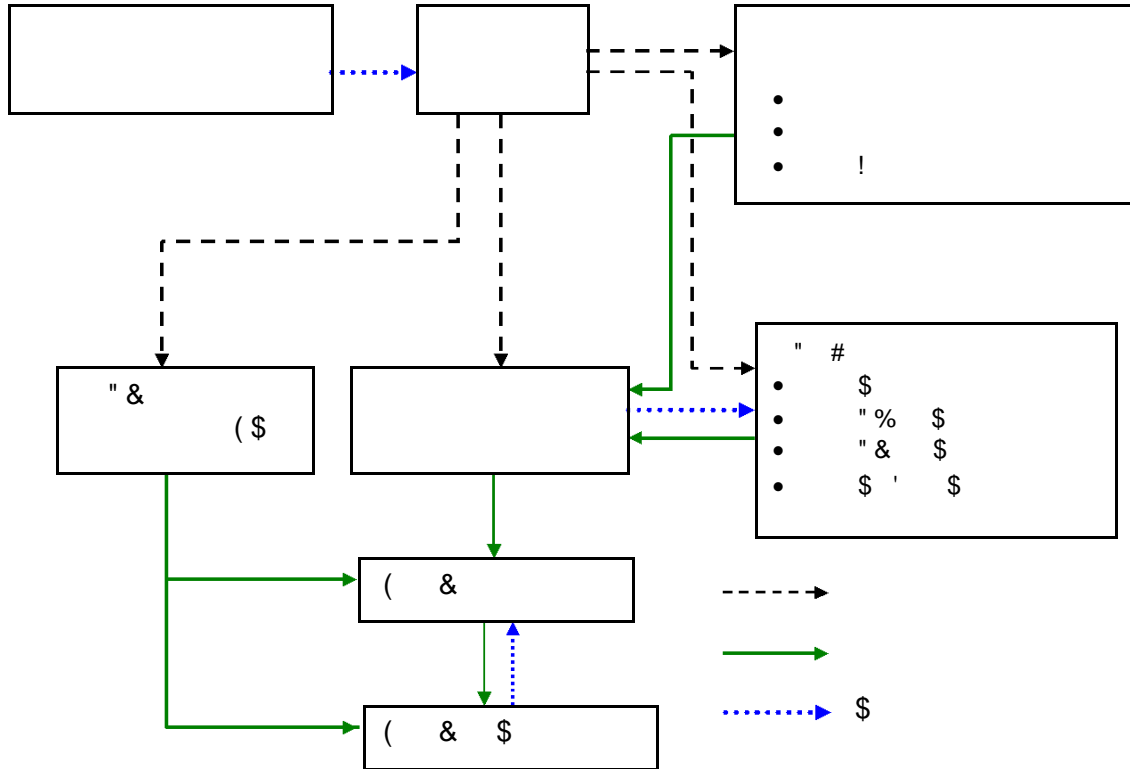

Figure 1. Organization of the formal maize seed system in Ethiopia

Research, breeding, and biodiversity conservation

The Ethiopian Institute of Agricultural Research (EIAR), a semi-autonomous body under the Ministry of Agriculture and Rural Development (MoARD), represents the main agency responsible for the coordination of agricultural research—and thus maize breeding—in Ethiopia. Its functions include maize breeding, production of breeder/foundation seed, and supply of breeder/foundation seed to basic seed producers. EIAR's maize-related activities are carried out at the Melkassa Agricultural Research Center (MARC), the Bako Agricultural Research Center (BARC), and several of the seven regional (i.e. state-level) agricultural research institutes (RARIs). These activities are further complemented by research conducted in Ethiopia's higher learning institutes (HLIs). The Institute for Biodiversity Conservation (IBC) is responsible for the conservation of the country's biological resources and thus plays a key role in the *ex-situ* and *in-situ* conservation of local maize germplasm, as well as the introduction of new maize germplasm to the country's existing stock from international sources.

The strategic focus of Ethiopia's public sector maize breeding programs is highlighted by efforts to develop improved maize varieties and hybrids for three specific types of zones (low, medium and high altitude maize-growing areas of the country); four types of varieties (extra-early, early, intermediate, and late maturing varieties); and four types of attributes (yield improvement, drought tolerance, earliness and disease resistance) (EARO, 2002; MoARD, 2004). Since the start of formal maize research in Ethiopia, about 27 maize varieties (18 OPVs and 9 hybrids) have been developed by public system, with an additional 3 hybrids developed by Pioneer Hi-Bred International, a US-based multinational company with operations in Ethiopia (MoARD, 2004). OPVs released specifically for drought-stressed areas (where cultivation is rain-fed only) include Katumani, Tesfa, Fetene, Melkassa-I, Melkassa-II, Melkassa-III, Melkassa-IV, Melkassa-V, and A - 511. These improved

varieties are grown alongside local varieties such as Sheye, Hararghe, Bukuri, Limat and China (Mandefro et al., 2002).

Seed industry regulation and management

In terms of seed industry regulation, the single most important players are (a) the National Varietal Release Committee (NVRC), the government body charged with testing and registering new varieties, and (b) the Agricultural Inputs Quality Control Department of the MoARD, the unit responsible for certifying seed for distribution and issuing licenses for seed production, processing, importing, retailing, and/or exporting. The Agricultural Inputs Marketing Department, another unit under the MoARD, is responsible for assessing national seed demand and supply, as well as development of strategies to address any shortages. These shortages typically result from changes in farmers' demand for seed, itself the result of their price and rainfall expectations.

Production, marketing and distribution

The Ethiopian Seed Enterprise (ESE) is the lynchpin of Ethiopia's seed industry. It is a state-owned enterprise responsible for the multiplication and distribution of improved seed for all major crops, specifically cereals, pulses, fruits, vegetables and forage (Table 1). ESE-produced seed is distributed to regional and *woreda* bureaus of agriculture for onward distribution to farmers. However, since the 2003/04 production season, the distribution of inputs (including seed) has also been routed through cooperative unions and cooperatives, thus representing a new channel for seed.

Over the last decade, the private sector has made some initial forays into Ethiopia's seed industry and more specifically, into the maize seed business. Some 26 firms are licensed to produce seed in the country, while 33 are licensed to retail and four to export seed

Table 1. Area allocated to maize seed production (1995/96 – 2004/05)

Year (cropping season)	Hybrids		OPVs		Total area (ha)	ESE share (percent)
	ESE (ha)	Total (ha)	ESE (ha)	Total (ha)		
1995/96	90	323	738	1,241	1,564	53
1996/97	228	794	465	465	1,259	55
1997/98	583	1719	331	331	2,050	45
1998/99	627	1,875	216	216	2,090	40
1999/00	932	3,268	230	260	3,528	33
2000/01	795	3,051	291	291	3,342	32
2001/02	417	1,743	421	421	2,164	39
2002/03	534	566	377	377	943	97
2003/04	483	906	400	400	1,306	68
2004/05	447	1,654	367	432	2,086	39

Source: Agricultural Inputs Marketing Department, MoARD (2005).

Table 2. Maize seed production and processing (1995/96 –2004/05)^a

Year	Hybrid maize seed				OPV maize seed				Total maize seed produced (qt)
	ESE (qt)	Total produced (qt)	Total processed (qt)	Total sold (qt)	ESE (qt)	Total produced (qt)	Total processed (qt)	Total sold (qt)	
1995/96	3,343	9,017	7,882	9,597	21,708	29,208	24,348	9,295	38,225
1996/97	6,075	16,924	13,494	11,540	9,719	9,719	4,446	5,140	26,643
1997/98	18,473	39,980	36,472	35,911	7,540	7,540	5,185	6,615	47,520
1998/99	20,031	44,597	40,593	41,444	4,223	4,223	4,431	4,053	48,820
1999/00	6,932	97,023	85,102	67,193	5,735	6,615	3,821	4,005	103,638
2000/01	12,440	93,870	63,785	1,789	6,802	6,802	3,583	2,977	100,672
2001/02	12,194	54,253	29,300	22,856	7,965	7,965	3,449	2,827	62,218
2002/03	9,753	10,065	22,347	52,196	5,107	5,107	6,368	6,928	15,172
2003/04	11,148	23,182	27,257	16,312	9,178	9,178	3,449	3,581	32,360
2004/05	8,444	50,591	45,532	48,562	6,136	8,411	6,729	8,022	59,003

^a“qt” denotes quintal.

Source: Agricultural Inputs Marketing Department, MoARD (2005). Note: In some years, the quantity produced is less than the quantity prepared and sold due mainly to seed reserves and carryover stocks from previous years.

However, only eight firms are actively engaged in seed production, primarily as contractors to ESE, which then distributes seed to state farms, regional/district bureaus of agriculture and more recently, cooperatives and cooperative unions. Of the private companies, only Pioneer Hi-Bred International is involved in the production and marketing of its own branded maize hybrids developed from breeding materials imported from Zimbabwe and South Africa (Aduagna and Melaku, 2002). (Table 2)

Yet in spite of the active participation of Pioneer and other companies in Ethiopia's seed industry, the size and reach of the private sector is extremely limited. And apart from Pioneer, few other firms are directly marketing their own products—most work for ESE as subcontractors. Moreover, very few of these companies produce maize varieties that are suitable to the agro-climatic conditions of the Rift Valley area. Other players—including international non-governmental organizations such as World Vision, CARE, and Catholic Relief Service—are involved in the production, marketing, and distribution of maize seed through a variety of community-based projects such as local seed banks and on-farm seed multiplication projects.

An assessment of the maize seed system and market

Ethiopia's capacity to meet the growing demand for improved maize seed is limited under the structure described above. This section describes the findings from focus group discussions with farmers in the Rift Valley Area, key informant interviews with stakeholders in Ethiopia's seed system, and analysis of the secondary data gathered from government and industry sources. Specifically, the section sets forth key issues relating to maize seed improvement, maize and maize seed prices, and maize seed preference and cultivation practices among farmers.

Maize seed improvement

The problem begins from the supply of breeder (basic) seed. The demand for these inputs to breeding and multiplication are consistently greater than the capacity of research centers to produce it in sufficient quantities.

The problem continues with the supply of foundation seed to pro-

Table 3a. Hybrid maize seed production by company, 2004

Company	Hybrid name	Amount produced (quintals)	Percent of total supply of specific hybrid	Percent of total hybrid supply
ESE	BH-660	23,293	71.0	70.0
	BH-670	405	100.0	
	BH-140	13,750	100.0	
	BH-540	13,261	95.0	
	BH-541	251	100.0	
	BHQP-542	1,145	100.0	
Pioneer Hi-Bred	Phb-3253	7,000	100.0	16.1
	Phb-30H-83	5,000	100.0	
Hawassa Agro Business Awassa Farm Development Enterprise	BH-660	180	0.6	0.2
	BH-660	962	3.0	1.3
Awassa Green Wood	BH-660	3,500	11.0	4.7
Hadiya Trading Enterprise	BH-660	1,100	3.3	1.5
Bako Agricultural Research Center	BH-660	2,397	7.3	4.3
	BH-540	765	5.5	
Ano Agro Industry Anger Farm	BH-660	612	1.9	0.8
	BH-660	842	2.6	1.1
Total	BH-660	32,886		
	BH-670	405		
	BH-140	13,750		
	BH-540	14,026		
	BH-541	251		
	BHQP-542	1,145		
	Phb-3253	7,000		
	Phb-30H-83	5,000		

Source: Agricultural Inputs Marketing Department, MoARD (2005).

duced certified seed stocks. Current practice does not require certified seed producers such as the ESE to renew their basic seed stocks for multiplication each year. Since few seed producers have adequate capacity to maintain genetic purity and other necessary qualities of their basic seed, there is concern that this has led to the multiplication and distribution of poor quality certified seed.

Other problems relate to the country's quality assurance system. Under the current system, any licensed seed producer can apply to the MoARD's Input Quality Control Department to obtain a supervisory assessment of their seed production process in order to secure certification. Expert supervision is provided out of one of eight federal quality control offices, and concentrates on such quality indications as the isolation of the production area, evaluation of the crop stand, and overall seed quality even after harvesting, threshing and cleaning. However, the system is designed and resourced to supervise medium to large-scale seed production operations, and is not geared toward the supervision of small-scale farmers engaged in seed production and multiplication.

Estimating maize seed demand and supply

The problems extend further into the entire system of estimating and meeting demand for maize seed in Ethiopia. Several experts and key informants to this study have argued that demand figures drawn from estimates produced by *woreda* and regional bureaus of

agriculture are largely meaningless. More importantly, these official demand figures probably mask the growing demand for improved maize seed and the growing demand for quality maize seed throughout Ethiopia. As a result, the supply of maize seed may be consistently falling short of demand: if only 53 percent of official demand was met in 2004, it is likely that the real shortfall was much larger. (Tables 3a and 3b)

The issue of meeting demand is further complicated by the tendency for farmers' to revise their expectations of maize prices and rainfall levels prior to planting, thus changing their demand for specific varieties of maize seed. Rapid and large-scale changes in expectations pose a challenge for a seed industry that is unable to stock a diverse variety of seed in anticipation of changes in farmer expectations. In some situations, this problem has led farmers to revert from improved varieties to local varieties, and for public and private maize seed producers to sell their seed as grain.

Seed production constraints

This problem is compounded by low efficiency in the current seed production system. Estimates from a farm sub-contracted by the ESE to produce seed for the 2004 production season reveal some of the underlying cost issues relating to maize seed production by a state-owned enterprise (Table 4). The farm's cost of producing an equinatal of seed was 392.30 Birr (US\$ 45.62) for hybrid maize

Table 3b. OPV maize seed production by company, 2004

Company	Variety	Amount produced (quintals)	Percent of total supply of specific variety	Percent of total OPV supply
ESE	A - 511	2,145	100	82
	Katumani	2,772	66	
	Gibe – 1	1,150	100	
	Kuleni	503	100	
Awassa Green Wood	Katumani	1,000	24	13
	Ethio-Flora	425	10	
Total	A – 511	2,145		5
	Katumani	4,197		
	Gibe – 1	1,150		
	Kuleni	503		

Source: Agricultural Inputs Marketing Department, MoARD (2005).

Table 4. Maize seed production costs for ESE (2004/05 production season)

Cost component	Cost of hybrid maize seed production		Cost of OPV maize seed production	
	Birr per quintal	percent of total cost	Birr per quintal	percent of total cost
Direct labor costs	32.74	8.35	28.31	6.95
Direct material costs	50.48	12.87	60.82	14.93
(Seed)	8.14	2.07	1.50	0.37
(Chemicals)	15.34	3.91	23.21	5.70
(Fertilizer)	17.18	4.38	26.00	6.38
(Harvesting & packing materials)	9.81	2.50	10.11	2.48
Center overhead	255.34	65.09	262.98	64.54
Enterprise contribution	53.74	13.70	55.34	13.58
Total production cost	392.30		407.46	

Source: Ethiopian Seed Enterprise (2005).

and 407.46 birr (47.38 US\$) for OPV maize. The difference in cost between hybrids and OPVs is explained by the relatively lower yield of OPVs: 14 quintals of seed per hectare for OPVs compared to about 21 quintals for hybrids. Furthermore, according to a key informant to this study, the average margin between the ESE's sales price and the farmer purchase price is 35 percent for both OPVs and hybrids, although variations exist between regions and woredas due to transportation costs. Overheads account for 54 percent of the per quintal costs for both.

By comparison, private seed companies can produce hybrid maize seed for just a third of the price because of far lower overheads and administration costs (Table 5). Having said this, it is likely that other indirect costs militate against private sector entry into the maize seed market, including the costs associated with navigating the regulatory system, accessing financing from the formal banking sector without non-agricultural collateral, or establishing independent distribution and marketing networks.

Prices and price volatility

Yet another challenge for Ethiopia's seed industry is the volatility of maize prices in the country's grain markets. This price volatility

affects the allocation of land for maize seed production and the total quantity of maize seed produced over the last decade (Tables 1 and 2). The volatility is particularly noticeable in hybrid seed production, where the effects of a bumper harvest of maize and a subsequent maize price collapse in the 2002 led to a dramatic decline in land allocated to hybrid seed production in 2002/03.

A related challenge is relatively low (and generally fixed) nominal prices for maize seed, and declining real prices over the past decade for almost all types of seed—about 550 Birr (63.95 US\$) per quintal for hybrids and about 250 Birr (29.07 US\$) per quintal for open-pollinated varieties, when measured in constant (2000) Birr. While the ESE sets its prices to generate a profit of 3 to 5 percent, the fact that demand so significantly exceeds supply suggests that the market can easily bear a higher margin. Moreover, there is potentially room to bring these seed prices into closer alignment with international or regional benchmarks that price hybrid seed at about a 10:1 ratio over the grain price relative to 5:1 in Ethiopia.

Preferences and practices: maize seed and the farmer

Other problems relate to the type of maize seed supplied by Ethiopia's seed industry. For example, in 2004, the ESE produced

Table 5. Breakdown of hybrid maize seed production costs, 2004/05

Cost component	Cost (ETB/quintal)	
	Ethiopia Seed Enterprise	Private seed multiplier
Direct labor costs	33	35
Direct material costs	50	48
Administration and Overheads	309	43
Total	392	125

Source: Ethiopian Seed Enterprise (2005); industry sources.

Table 6. Socio-demographic characteristics of sampled households

Socio-demographic indicators		Type of maize variety			F-value	Total
		Local	Improved	Both		
Education (years of formal education)	Mean	2.54	4.58	4.18	1.59	4.07
	Std	2.37	3.92	3.37		
Age in years of the household head (years)	Mean	40.54	41.00	38.09	0.41	40.37
	Std	9.12	9.91	7.82		
Family size (No of persons)	Mean	6.92	8.11	9.73	1.70	8.15
	Std	3.20	3.79	4.03		
Own land (kert)	Mean	7.92	7.08	12.66	5.59***	8.28
	Std	4.54	3.69	7.91		
Total land (in kert)	Mean	9.85	8.65	14.75	4.74***	10.03
	Std	4.98	3.98	10.20		
No of parcels of land operated	Mean	2.77	3.06	3.55	0.73	3.08
	Std	1.36	1.49	2.07		
Distance to woreda town (km)	Mean	26.08	29.35	22.00	0.70	27.29
	Std	18.17	19.73	13.58		
Distance to DA office (km)	Mean	1.81	1.83	2.36	0.28	1.92
	Std	1.63	2.45	1.69		
Access to credit	percent of farmers	38	31	45		35
Cooperative membership	percent of farmers	85	92	100		92

Note: *** denotes significance at the 1 percent level.

Source: Survey data

approximately 82 percent of all OPV maize seed and 70 percent of all hybrid maize seed. This left open a small but not insignificant part of the maize seed market open to private companies and other players (Tables 3a and 3b). But, as might be expected, private maize seed production was concentrated on hybrids, with only two private companies producing OPVs.

There is also the issue of farmers' cultivation practices. Farmers in Ethiopia often recycle maize seed—even hybrid seed, despite significant losses in vigor from planting saved seed (Aduugna and Melaku, 2002). These practices are often the result of farmers' insufficient knowledge about the need to renew seed on a regular basis, inadequate access to credit needed to purchase new seed or other related constraints.

Access and use of improved maize seed in the rift valley area

Using data collected from 60 randomly-selected maize growers in the area (as described above), this section provides estimates of the key determinants of their adoption decisions.

Descriptors of the sampled farmers are given in Table 6. Total land operated and owned (two closely correlated variables) showed significant differences between farmers cultivating different types of maize varieties. Those farmers who grew both improved and local varieties showed high levels of land (both owned and operated) compared to those growing only local varieties or only improved varieties. However, the number of parcels operated did not vary significantly among farmers growing different maize varieties. Distance to market and development centers also did not vary among farmers growing different maize varieties.

Access to services like credit and cooperatives show that about 35 percent of the sampled households have access to credit and 92 percent were members of a cooperative. A higher proportion of farmers who grow both local and improved maize varieties had access to these services as compared to those who grow only local or improved varieties. Descriptive statistics also show that a considerable proportion of maize growers in the Rift Valley area use improved maize varieties (60 percent) and about 22 percent grow only local varieties and the remaining 18 percent grow both local and improved varie-

Table 7. Farm size and land allocation to maize production

Type of maize variety	Indicators	Total Farm size (ha)	Maize area (ha)	Improved maize area (ha)	Proportion of total farm size allocated to maize	Proportion of maize land allocated to improved varieties
Local	Mean	2.23	1.17	0	0.57	0.00
	Std	1.08	0.78	0	0.29	0.00
Improved	Mean	2.14	1.07	1.06	0.52	1.00
	Std	0.97	0.55	0.55	0.17	0.00
Both	Mean	3.47	1.78	0.84	0.56	0.52
	Std	2.23	1.01	0.60	0.18	0.25
Total	Mean	2.40	1.22	0.79	0.54	0.69
	Std	1.38	0.74	0.65	0.20	0.42
F-Value		4.57**	4.38**	21.62***	0.38	463.69***

Note: *** indicates 1 percent and ** 5 percent significance levels. The F-value denotes the test for the mean difference among farmers growing the different types of maize varieties.

Source: Survey data.

Table 8. Maize seed source in 2005 crop season.

Seed source	Percent of farmers (n=60)
Own seed	43
Traders in market	15
Bureau of Agriculture (BoA)	12
Other farmer (s)	12
BoA and own seed	8
Cooperatives/Union	5
Other farmers and own seed	2
Other farmers and traders	2
Traders and own seed	2

Source: Survey data.

ties. The land allocated for maize varied among farmers based on the type of seed used. Farmers using both local and improved maize seed allocated more land to maize production followed by those using local seed only (Table 7).

The major source of maize seed for the maize growing farmers in the Rift Valley area is own seed (43 percent of the farmers) followed by seed bought from traders (15 percent), the bureau of agriculture (12 percent), and other farmers (12 percent) (Table 8).

The surveyed farmers cultivated a variety of hybrids (BH 660, BH 540 and BH 140) and OPVs (A - 511 and Katumani). According to farmer responses, the choice between the various hybrids and OPVs relates mainly to the availability of seed and their qualities: the popular hybrid varieties are preferred for their wider adaptability, good drought tolerance and high yield. While many farmers were originally discouraged from planting maize hybrids due to the area's susceptibility to drought-related stress, many choose to plant hybrids if the early (April) rains are adequate.

OPVs and hybrid maize seed were obtained by the surveyed farmers from different sources. The local Bureau of Agriculture constituted the main source for the BH-660 hybrid, while other hybrids were obtained from a variety of other sources. Other farmers, own seed and traders represent the main sources for OPVs. These figures suggest that a considerable portion of the improved seed cultivated by the surveyed farmers is saved seed for both OPVs and hybrids.

About 84 percent of the surveyed farmers reported that they do not receive their required type of maize seed from any source including farmers using own seed, while 56 percent indicated that they do not receive the required quantity and 20 percent indicated that they do not receive the required quality (Table 9).

Conclusions and recommendations

This paper reviews the structure, actors, and performance of Ethiopia's maize seed industry. In doing so, it provides a novel analysis of the challenges facing key players engaged in maize seed production and distribution in the country. With respect to maize varieties developed for drought-prone areas such as the Rift Valley, Ethiopia's national agricultural research system has made significant progress with the development of several varieties that are appropriate to farmers' needs and the constraints imposed by the area's agro-ecology. However, the ultimate availability of these varieties remains limited due to a weak production, distribution, and marketing system.

Evidence suggests that private sector participation in the maize seed industry is increasing, particularly with respect to the production and distribution of maize hybrids. However, the public sector remains the key player in the country's seed industry. This includes the national agricultural research system, the ESE, the *woreda* and regional bureaus of agriculture, and various regulatory agencies under the MoARD. There is scope for greater private sector participation in the production, distribution and marketing of maize seed, particularly given that the private sector's cost basis may be more competitive than the public sector's in maize seed. Greater participation by the private sector may, in turn, help to address the current shortfall of maize seed in the market.

Evidence also suggests the continued need for a strong

Table 9. Availability of seed in terms of type, quality and quantity

Availability in terms of type, quality and quantity	Percent of farmers answering “No”	Proportion for Maize (percent)
Do you get the required type of seed each year?	50.00	84.00
Do you get the required quantity of seed each year?	53.33	56.00
Do you get the required quality of seed each year?	25.00	20.00

Source: Survey data.

regulatory system to ensure seed quality in production and distribution processes—a function that the public sector is most appropriately configured to undertake. However, reforms in the regulatory system procedures are needed, particularly with respect to the time and effort required by seed producers to be evaluated for production suitability, management and quality. Such reforms could significantly encourage greater private investment in the seed industry.

Several recommendations for improving the maize seed production and distribution system in Ethiopia are as follows:

I. Promote greater private investment in the production of maize seed and in the establishment of independent distribution and marketing channels to farmers.

II. Invest in greater production of breeder/foundation and pre-basic seed production. Possible interventions include increasing production capacity by subcontracting to public and private farms and investing in irrigation to support these farms.

III. Invest further in reducing the costs of seed certification to make certified seed multiplication by small-scale farmers more feasible by strengthening the decentralized certification procedures and capacity of the staff involved.

IV. Continue to invest in seed-related extension programs to encourage the adoption of improved maize varieties and provide training to development agents on alternative varieties for agro-ecologies such as the drought-prone Rift Valley area.

V. Significant structural and organizational change to the maize seed system along these lines may help address the market and institutional failures, ultimately improving smallholder access to improved maize varieties developed for drought-prone regions such as the Rift Valley.

ACKNOWLEDGEMENTS

The authors gratefully acknowledge the financial and technical support given by the International Maize and Wheat Improvement Center (CIMMYT) and the Ethiopian Institute of Agricultural Research (EIAR) to undertake this study; and the comments from an anonymous reviewer.

REFERENCES

- Aduugna N, Melaku A (2002). Hybrid maize seed production and commercialization: the experience of Pioneer Hi-Bred Seeds in Ethiopia. In: N. Mandefro, D.G. Tanner and T. Afriyie (eds.), Proceedings of the Second National Maize Workshop of Ethiopia. Addis Ababa: Ethiopian Agricultural Research Organization (EARO), pp. 166–169.
- Bandiera O, Rasul I (2006). Social networks and technology adoption in Northern Mozambique. *Econ. J.* 116: 869-902.
- Banziger M, Diallo AO (2001). Stress-tolerant maize for farmers in sub-Saharan Africa. In: International Maize and Wheat Improvement Center (CIMMYT), The Maize Program. Maize Research Highlights 1999-2000, Mexico, D.F.: CIMMYT, pp. 1-8.
- Banziger M, Diallo AO (2002). Progress in developing drought and N stress tolerant maize cultivars for Eastern and Southern Africa. Paper presented at the Seventh Eastern and Southern Africa Regional Maize Conference, 5-11 February 2002, Nairobi, Kenya.
- Bardhan P, Udry C (1999). *Development Microeconomics*. Oxford: Oxford University Press. ISBN-10: 0198773714.
- Bedru Beshir (2007). Maize demonstration and evaluation in the Rift Valley. Progress report. Melkassa Research Center. Ethiopian Institute of Agricultural Research.
- Besley T, Case A (1994). Diffusion as Learning Process: Evidence from HYV Cotton. RPDS Discussion Paper no. 174. Princeton: Princeton University.
- Bett C, Muhammad L, Mwangi W, Njoroge K (2003). The seed industry in semi-arid eastern Kenya. In: CIMMYT and EARO, Maize Production Technology for the Future: Challenges and Opportunities. Proceedings of the Sixth Eastern and Southern Africa Regional Maize Conference, 21-25 September, 1998, Addis Ababa, Ethiopia. Addis Ababa: CIMMYT/EARO.
- Byerlee D, Spielman DJ, Alemu D, Gautam M (2007). Policies to Promote Cereal Intensification in Ethiopia: A Review of Evidence and Experience. International Food Policy Research Institute (IFPRI) discussion paper no. 707. Washington, D.C.: IFPRI.
- CSA (Central Statistical Authority), Federal Democratic Republic of Ethiopia (2006). Statistical Abstracts. Addis Ababa: CSA.
- CSA (Central Statistical Authority), Federal Democratic Republic of Ethiopia (2004). Statistical Abstracts. Addis Ababa: CSA.
- CSA (Central Statistical Authority), Federal Democratic Republic of Ethiopia (2001). Statistical Abstracts. Addis Ababa: CSA.
- Dawit A, Spielman DJ (2006). The Ethiopian seed system: Regulations, institutions and stakeholders. Paper presented at the Ethiopia Strategy Support Program (ESSP) Policy Conference 2006, Bridging, Balancing, and Scaling up: Advancing the Rural Growth Agenda in Ethiopia, 6-8 June, 2006, Addis Ababa, Ethiopia.
- Dawit A, Deressa A, Dessalegne L, Anchala C (2004). Domestic vegetable seed production and marketing. Research Report No. 57. Ethiopian Agricultural Research Organization.
- Deressa A., Admassu H, Seboka B, Nigussie M (2001). Participatory secondary improved maize (*Zea mays* L) seed multiplication in the central Rift Valley of Ethiopia. In: Proceedings of the Seventh Eastern and Southern Africa Regional Maize Conference, 5-11 February 2002, Nairobi, Kenya. Nairobi: CIMMYT.
- Diallo AO, Kikafunda J, Wolde L, Odongo O, Mduruma ZO, Chivatsi WS, Friesen DK, Mugo S, Banziger M (2002). Drought and low nitrogen tolerant hybrids for the moist mid-altitude ecology of Eastern

- Africa. Paper presented at the Seventh Eastern and Southern Africa Regional Maize Conference, 5-11 February, Nairobi, Kenya.
- EARO (Ethiopian Agricultural Research Organization) (2002). *Strategies and Priorities for Maize Research*. Addis Ababa: EARO.
- Foster AD, Rosenzweig MR (1995). Learning by doing and learning from others: Human capital and technical change in agriculture. *J. of Political Econ.* 103(6): 1176-1209.
- Gerpacio RV (2003). The roles of public sector versus private sector in R&D and technology generation: The case of maize in Asia. *Agric. Econ.* 29(3): 319-330.
- Mandefro N, Mohammed H, Sebokssa G, Bogale G, Beyene Y, Hailemichael S, Hadis A (2002). Maize improvement for drought stressed areas of Ethiopia. In: N. Mandefro, D.G. Tanner and T. Afriyie (eds.), *Proceedings of the Second National Maize Workshop of Ethiopia*. Addis Ababa: Ethiopian Agricultural Research Organization (EARO), pp. 15-26.
- MoARD (Ministry of Agriculture and Rural Development, Federal Democratic Republic of Ethiopia) (2004). *Crop variety register*. Issue No. 7. Addis Ababa: Crop Development Department. MoARD.
- MoARD (Ministry of Agriculture and Rural Development, Federal Democratic Republic of Ethiopia) (2005). various official documents and records from the Agricultural Inputs Marketing Department. Addis Ababa: MoARD.
- Morris ML, Rusike J, Smale M (1998a). Maize seed industries: A conceptual framework. In: M. L. Morris (ed.), *Maize seed industries in developing countries*. London: Lynne Rienner Publishers.
- Morris M, Singh R, Pal S (1998b). India's maize seed industry in transition: Changing roles for the public and private sectors. *Food Policy* 23: 55-71.
- Muasya WNP, Diallo AO (2002). Development of early and extra early drought and low nitrogen-tolerant varieties using exotic and local germplasm for the dry mid-altitude ecology. Paper presented at the Seventh Eastern and Southern Africa Regional Maize Conference, 5-11 February, Nairobi, Kenya.
- Muhammad L, Njoroge K, Bett C, Mwangi W, Verkuil H, De Groote H (2003). The seed industry for dryland crops in Eastern Kenya. Mexico, D.F.: CIMMYT and Kenya Agricultural Research Institute (KARI).
- Munshi K (2004). Social learning in a heterogeneous population: social learning in the Indian green revolution. *J. of Dev. Econ.* 73: 185-213.
- Mywish M, Howard J, Bouhton D (1999). Increasing seed system efficiency in Africa: Concepts, strategies and issues. *International Development Working Paper*. East Lansing, MI: Michigan State University.
- Siambi M, Diallo AO, De Groote H, Friesen DK, Muasya WNP (2002). Recent developments in participatory plant breeding for maize in Eastern Africa: Experiences from Eastern Kenya. Paper presented at the Second National Maize Workshop of Ethiopia, 12-16 November, Addis Ababa, Ethiopia.
- Tripp R (2001). Can biotechnology reach the poor? The adequacy of information and seed delivery. *Food Policy* 26: 249-264.
- Tripp R, Louwaars N (1997). Seed regulation: Choices on the road to reform. *Food Policy* 22: 433-446.
- Tripp R, Pal S (2001). The private delivery of public crop varieties: Rice in Andhra Pradesh. *World Dev.* 29 (1): 103-117.
- Tripp R, Rohrbach D (2001). Policies for African seed enterprise development. *Food Policy* 26: 147-161.
- Worku M, Tuna H, Abera W, Wolde L, Diallo AO, Afriyie ST, Guta A (2002). Developing low-N tolerant maize varieties for mid-altitude sub-humid agro-ecology of Ethiopia. Paper presented at the Seventh Eastern and Southern Africa Regional Maize Conference, 5-11 February, Nairobi, Kenya.